

St Thomas School, Dhurwa, Ranchi – 4

Home assignment

Std. – I

Sub: Maths

1. Name of the book : MATHEMATICS FOREVER

Author : P.J. GEORGE & Sr. JAYANTI, SND

Following questions to be done in CW copy & each topic to be done date wise.

Chapter – Numbers on Abacus

Date : 01/06/2020

Write the numerals in the boxes.

1. T O

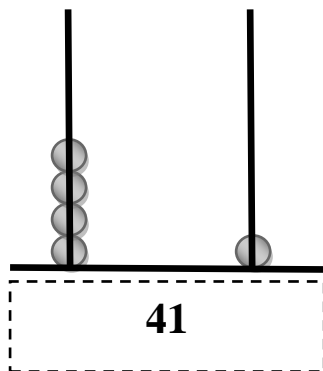

2. T O

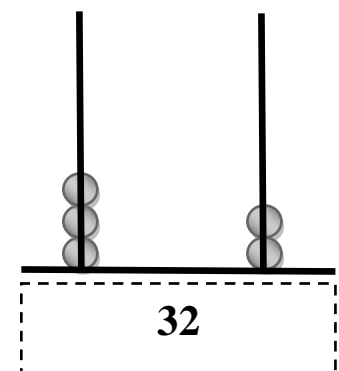

3. T O

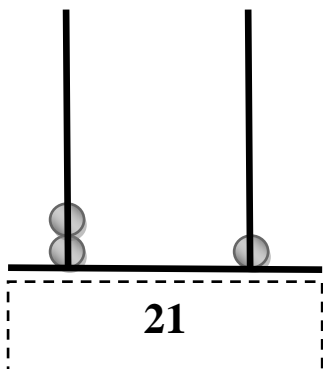

4. T O

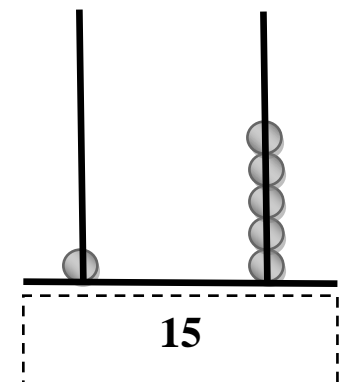

Date : 02/06/2020

Write the numerals in the boxes.

1. T O

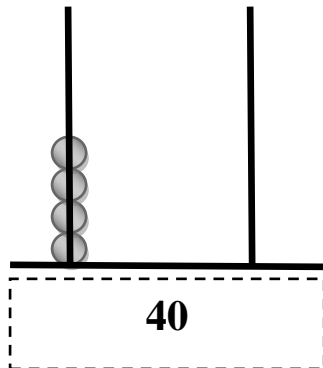

2. T O

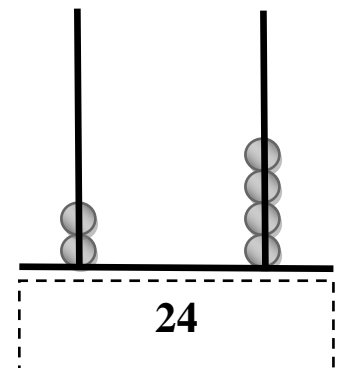

3. T O

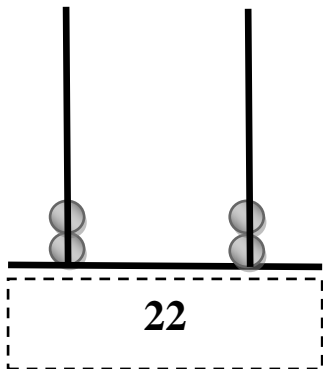

4. T O

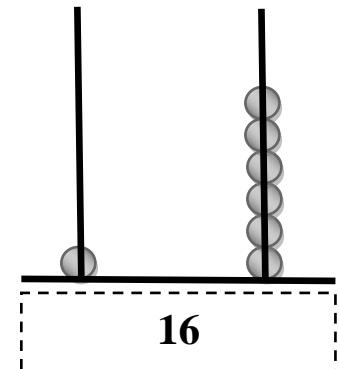

Date : 03/06/2020

Fill in the blanks.

1. T O

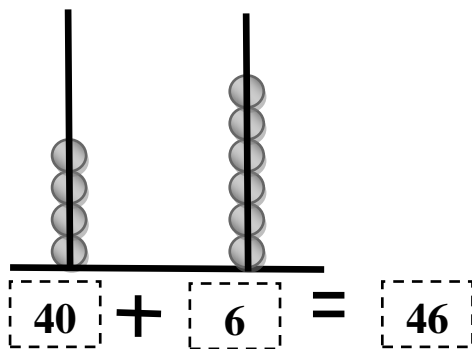

2. T O

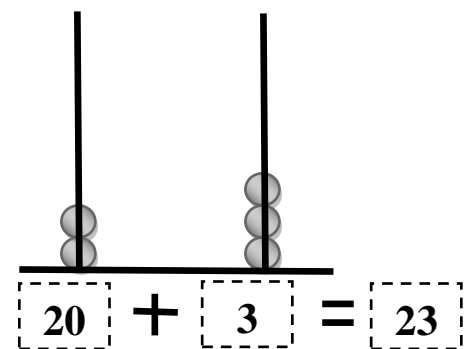

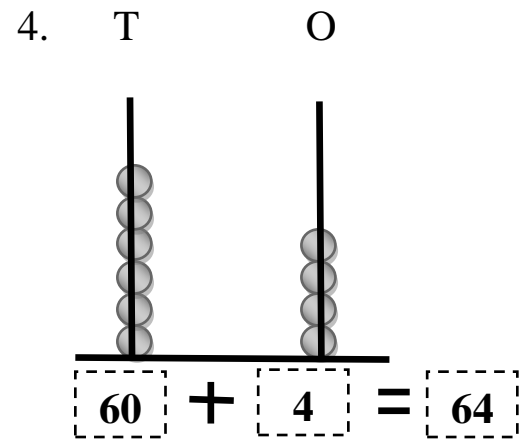
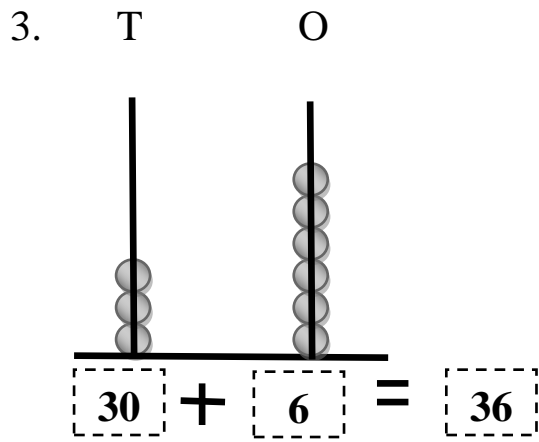

Date : 04/06/2020

Fill in the blanks.

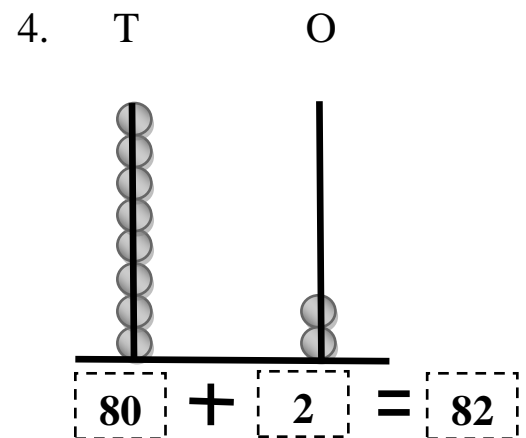
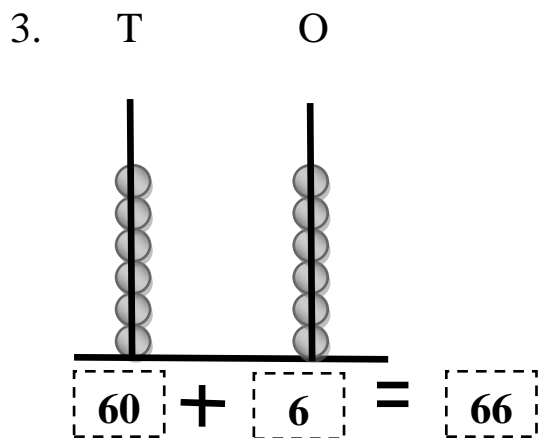
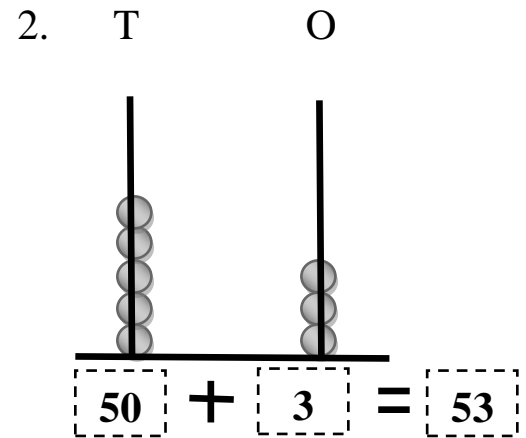
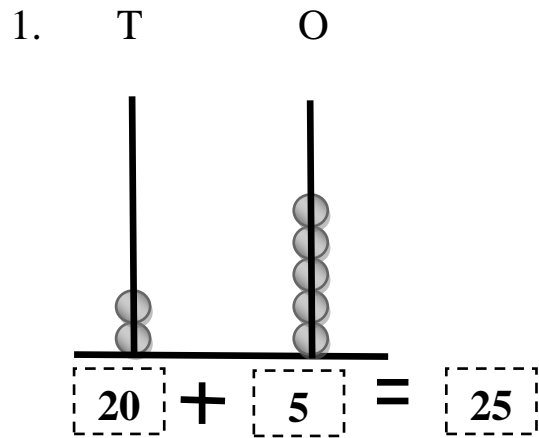

Date : 05/06/2020

Draw the beads on the abacus for the following numbers :

1. T O

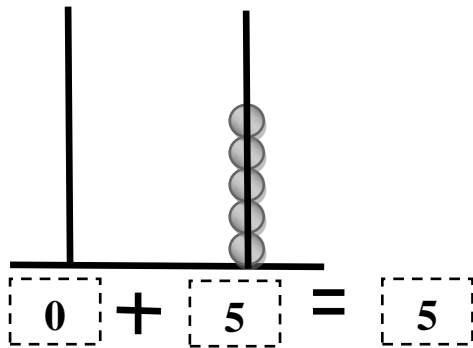

2. T O

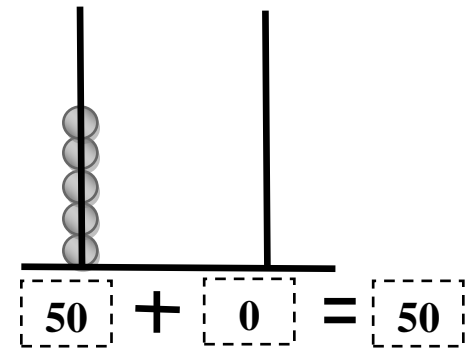

3. T O

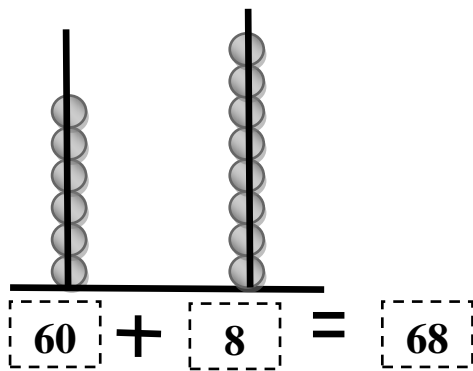

4. T O

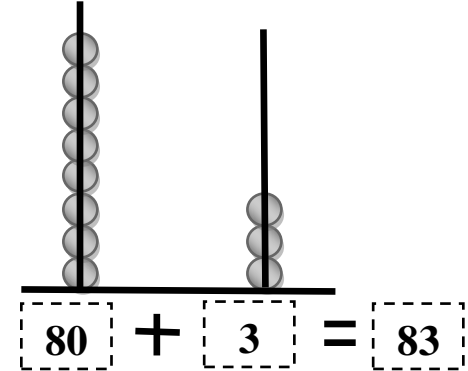

Date : 08/06/2020

Draw the beads on the abacus for the following numbers :

1. T O

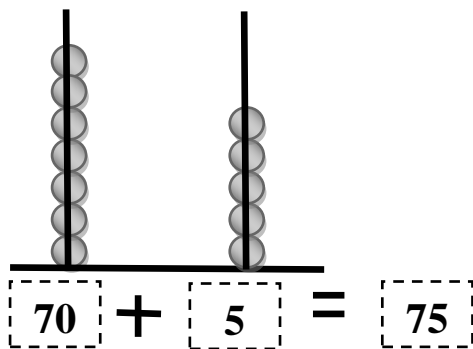

2. T O

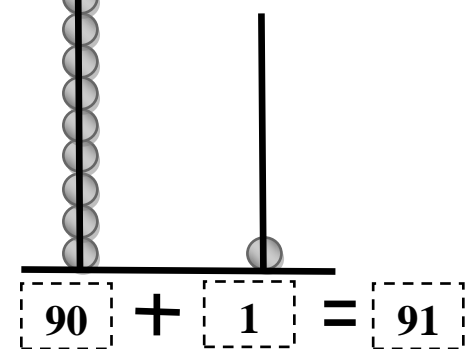

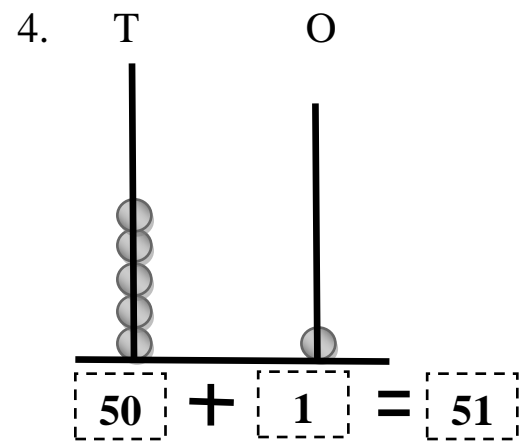
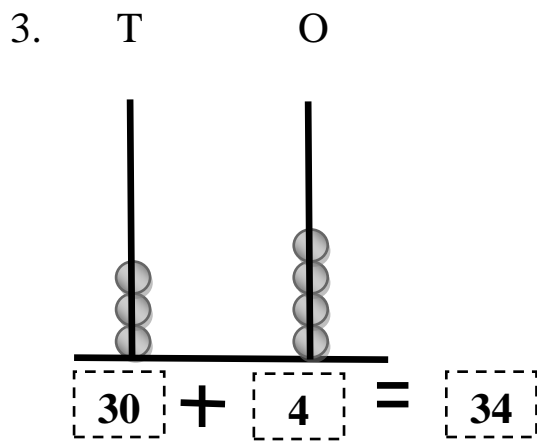

Date : 09/06/2020

Chapter: Ascending and descending order

Arrange the following numbers in Ascending order :

- (a) 50 to 58 – 50, 51, 52, 53, 54, 55, 56, 57, 58
 (b) 70 to 76 – 7, 71, 72, 73, 74, 75, 76
 (c) 89 to 95 – 89, 90, 91, 92, 93, 94, 95
 (d) 37 to 42 – 37, 38, 39, 40, 41, 42

Date : 10/06/2020

Arrange the following numbers in Ascending order :

- (a) 29, 0, 18, 7, 24, 12 – , 7, 12, 18, 24, 29
 (b) 19, 10, 12, 3, 2, 4 – 2, 3, 4, 10, 12, 19
 (c) 50, 3, 5, 33, 56, 19 – 3, 5, 19, 33, 50, 56
 (d) 51, 78, 60, 85, 68, 90 – 51, 60, 68, 78, 85, 90

Date : 11/06/2020

Write the numbers in descending order :

- (a) 69 to 63 – 69, 68, 67, 66, 65, 64, 63
 (b) 85 to 79 – 85, 84, 83, 82, 81, 80, 79
 (c) 94 to 87 – 94, 93, 92, 91, 90, 89, 88, 87
 (d) 25 to 19 – 25, 24, 23, 22, 21, 20, 19

Date : 12/06/2020

Arrange the following numbers in Descending order :

- (a) 19, 28, 4, 6, 49, 50 – 50, 49, 28, 19, 6, 4
(b) 20, 11, 2, 18, 32, 5 – 32, 20, 18, 11, 5, 2
(c) 2, 13, 37, 90, 51, 79 – 90, 79, 51, 37, 13, 2
(d) 85, 68, 99, 16, 11, 19 – 99, 85, 68, 19, 16, 11

Ordinal Numbers

Date : 15/06/2020

<i>Number</i>	<i>Ordinal</i>	<i>Symbol</i>
1	First	1 st
2	Second	2 nd
3	Third	3 rd
4	Fourth	4 th
5	Fifth	5 th
6	Sixth	6 th
7	Seventh	7 th
8	Eighth	8 th
9	Ninth	9 th
10	Tenth	10 th

Date : 16/06/2020

Write the ordinal number for the days :

- Sunday – First day
Monday – Second day
Tuesday – Third day
Wednesday – Fourth day
Thursday – Fifth day
Friday – Sixth day
Saturday – Seventh day

Date : 17/06/2020

Write the Ordinal for the following numbers:

<i>Number</i>	<i>Ordinal</i>
1	First
3	Third
5	Fifth
7	Seventh
9	Ninth

Date : 18/06/2020

Write the Ordinal for the following numbers:

<i>Number</i>	<i>Ordinal</i>
2	Second
4	Fourth
6	Sixth
8	Eighth
10	Tenth

Date : 19/06/2020

Fill in the blanks :

<i>Ordinal</i>	<i>Symbol</i>
First	1 st
Fourth	4 th
Fifth	5 th
Seventh	7 th
Ninth	9 th
Tenth	10 th

Date : 22/06/2020

Complete the following pattern : (2's)

- a) 2, 4, 6, 8, 10, 12
- b) 12, 14, 16, 18, 20, 22
- c) 24, 26, 28, 30, 32, 34
- d) 34, 36, 38, 40, 42, 44
- e) 52, 54, 56, 58, 60, 62

Date : 23/06/2020

Complete the following pattern : (5's)

- a) 5, 10, 15, 20, 25, 30
- b) 22, 27, 32, 37, 42, 47
- c) 33, 38, 43, 48, 53, 58
- d) 1, 6, 11, 16, 21, 26
- e) 14, 19, 24, 29, 34, 39

Date : 24/06/2020

Complete the following pattern : (10's)

- a) 5, 15, 25, 35, 45, 55
- b) 10, 20, 30, 40, 50, 60
- c) 3, 13, 23, 33, 43, 53
- d) 7, 17, 27, 37, 47, 57
- e) 12, 22, 32, 42, 52, 62